

ACU RITE®



Instruction Manual

AcuRite® Atlas™
Outdoor Device
model 06059

How It Works

AcuRite® Atlas™ is an environmental monitoring station that delivers key information on current outdoor conditions at its installation location. The outdoor device contains sensors that read temperature, humidity, wind speed and direction, rainfall, UV, light intensity, and optionally lightning (requires optional Lightning Detection Sensor; may be purchased separately). These readings are transmitted over a 433 MHz wireless radio frequency to be received by the AcuRite Atlas indoor HD display and/or AcuRite® Access™. Readings received by AcuRite Access can be monitored and viewed online from My AcuRite. Receivers may not be included, and may be purchased separately.

Set Up Your AcuRite® Atlas™

1 Verify Package Contents

1. AcuRite Atlas outdoor device
2. Mounting bracket (for optional use)
3. Mounting anchors & screws (for optional use)
4. Lightning Detection Sensor (optional; may be purchased separately)

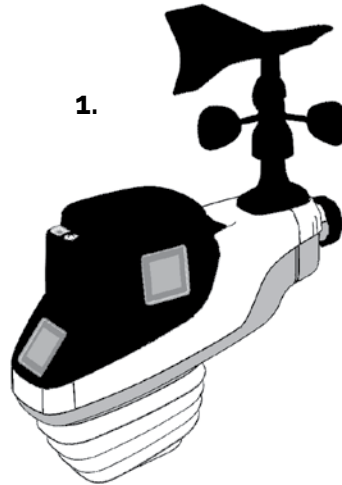

2.

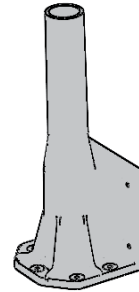

3.



4.



Device Components

1. Wind speed anemometer
2. Mounting knob
3. Battery compartment
4. Solar cell
5. Bubble level
6. UV and light sensor
7. Rainfall collector
8. Wind direction vane

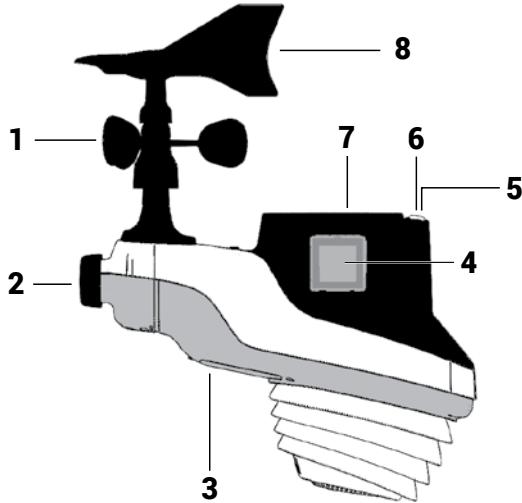

2 Install Batteries

Open the battery compartment, and insert four (4) AA alkaline or lithium batteries. Lithium batteries are recommended in low temperature conditions, especially below -4°F (-20°C).

Note: Heavy duty or rechargeable batteries are not recommended.

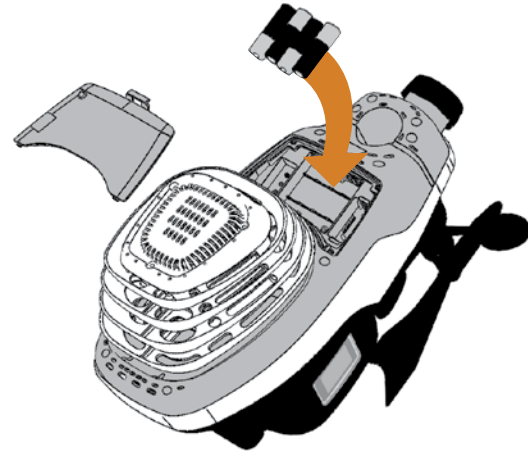

3 Optional: Install Lightning Detection Sensor

If you have the optional Lightning Detection Sensor, insert it in the battery compartment firmly until it clicks.

Note: If you do not have a Lightning Detection Sensor, you can always add one later. Visit www.Acurite.com for more information.

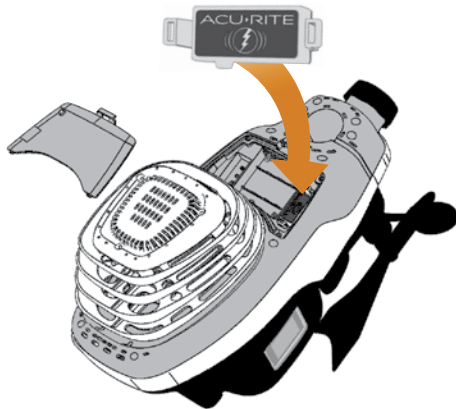

4 Mount Device Outdoors

AcuRite sensors are sensitive to surrounding environmental conditions. Proper placement of the outdoor device is critical to the accuracy and performance of this product.

Outdoor Device Placement

AcuRite Atlas is designed to remain outdoors all year long. Mount the outdoor device in a location that meets all the requirements below:

- Located within 330 feet (100 m) of receiving device (AcuRite Atlas indoor display or AcuRite Access)
- Some construction materials and other sources of interference may reduce this distance.
- At least 5 feet (1.5 meters) off the ground
- Rear solar panel is facing south
- Away from heat and humidity sources
- Level for accurate rain reporting

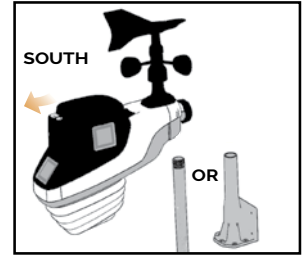

Placement for Maximum Accuracy

Important Additional Placement Guidelines

Choose an open location with no obstructions above or around the outdoor device for the most accurate measurements.

Maximize Wireless Range

Place outdoor device away from large metallic items, thick walls, metal surfaces, or other objects that may limit wireless communication.

Maximize Temperature Accuracy

Position outdoor device away from heaters, air conditioners, chimneys, exhaust vents, asphalt and concrete (surfaces that radiate heat).

Maximize Humidity Accuracy

Avoid installing the outdoor device near pools, spas, or other bodies of water.

Maximize Wind Accuracy

It's recommended to mount the outdoor device at least 5 feet (1.5 meters) off the ground, higher is better for wind measurement. The National Weather Service recommends 33 feet (10 meters) high. Avoid nearby wind obstructions such as trees and buildings. Be sure to mount the outdoor device securely, as swaying or shaking may cause inaccurate rain or wind readings.

Note: Consider the optional Wind Extension kit (may be purchased separately) to extend the wind speed and

direction sensors an additional 30 feet (9 meters) from the outdoor device to maximize the accuracy of wind measurements.

Locate Away from Sprinkler Heads

DO NOT install the outdoor device where it will be sprayed by a sprinkler system. This may force water inside the device.

Adjust the Wind Vane Orientation (Optional)

Note: Most users will not need to complete this step.

When mounting the AcuRite Atlas outdoor device, as long as the rear solar panel is facing south, the wind orientation should already be correctly configured from the factory. However, if you must mount the outdoor device in a different direction or otherwise need to adjust its wind vane orientation, complete the steps below.

1. In the battery compartment of the outdoor device, locate and press the calibration button. The red LED starts flashing rapidly.
2. Point the wind vane to north. You may need a compass to find the proper north orientation.
3. While holding the vane facing north, press the calibration button in the battery compartment again. The LED will stop flashing rapidly. Wind direction information will now use the new orientation.

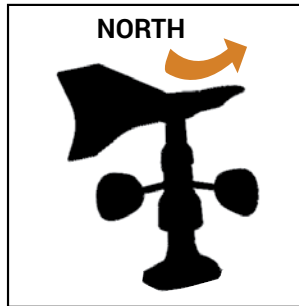
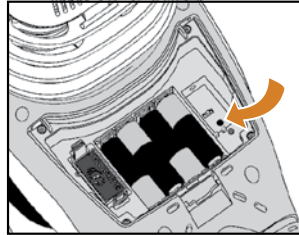

Specifications for Outdoor Device

Operating Range	Reading Frequency	Accuracy
TEMPERATURE RANGE		
-40 to 158°F (-40 to 70°C)	30 seconds	± 1°F
HUMIDITY RANGE		
1-100% RH	30 seconds	± 2%RH
WIND SPEED		
0-160 mph (0-257 km/h)	10 seconds	± 1mph ≤ 10 mph ± 10% > 10 mph
WIND DIRECTION		
360°	30 seconds	± 3°
RAIN		
.01 inch intervals (mm)	30 seconds	± 5%
UV INDEX		
0 to 15 index	30 seconds	± 1
LIGHT INTENSITY		
to 120,000 Lumens	30 seconds	n/a
*LIGHTNING		
Up to 25 miles away (40 km)	10 seconds	n/a

HAVING PROBLEMS?

We're Here to Help.

Visit us online  www.AcuRite.com

Get more information or download the full AcuRite Atlas™ product manual.

FCC Statement

This device complies with part 15 of the FCC rules. Operation is subject to the following two conditions:

- 1- This device may NOT cause harmful interference, and
- 2- This device must accept any interference received, including interference that may cause undesired operation.

NOTE: This equipment has been tested and found to comply with the limits for a Class B digital device, pursuant to Part 15 of the FCC rules. These limits are designed to provide reasonable protection against harmful interference in a residential installation. This equipment generates, uses and can radiate radio frequency energy and, if not installed and used in accordance with the instructions, may cause harmful interference to radio communications. However, there is no guarantee that interference will not occur in a particular installation. If this equipment does cause harmful interference to radio or television reception, which can be determined by turning the equipment off and on, the user is encouraged to try to correct the interference by one or more of the following measures:

- Reorient or relocate the receiving antenna.
- Increase the separation between the equipment and the receiver.
- Connect the equipment into an outlet on a circuit different from that to which the receiver is connected.
- Consult the dealer or an experienced radio/TV technician for help.

NOTE: The manufacturer is not responsible for any radio or TV interference caused by unauthorized modifications to this equipment. Such modifications could void the user authority to operate the equipment.

©Chaney Instrument Co. All rights reserved. AcuRite is a registered trademark of the Chaney Instrument Co., Lake Geneva, WI 53147. All other trademarks and copyrights are the property of their respective owners. AcuRite uses patented technology.

Visit www.AcuRite.com/patents for details.

Limited One (1) Year Warranty

AcuRite is a wholly owned subsidiary of Chaney Instrument Company. For purchases of AcuRite products, AcuRite provides the benefits and services set forth herein. For purchases of Chaney products, Chaney provides the benefits and services set forth herein. We warrant that the AcuRite Atlas Environmental Monitoring station premium product we manufacture and cover under this warranty is of good material and workmanship and, when properly installed and operated, will be free of defects for a period of one (1) year from the date of purchase.

The AcuRite Atlas Environmental Monitoring station which, under normal use and service, is proven to breach the warranty contained herein within ONE (1) YEAR from date of sale will, upon examination by us, and at our sole option, be repaired or replaced by us. Transportation costs and charges for returned goods shall be paid for by the purchaser. We hereby disclaim all responsibility for such transportation costs and charges. This warranty does not cover normal wear and tear not affecting the functionality of the product, or products that have been damaged (including by acts of nature), tampered with, abused, improperly installed, or repaired or altered by anyone other than our authorized representatives. Remedy for breach of this warranty is limited to repair or replacement of the defective item(s). If we determine that repair or replacement is not feasible, we may, at our option, refund the amount of the original purchase price (excluding shipping).

THE ABOVE-DESCRIBED WARRANTY IS THE SOLE WARRANTY FOR THE ACURITE ATLAS ENVIRONMENTAL MONITORING STATION PREMIUM PRODUCT AND IS EXPRESSLY IN LIEU OF ALL OTHER WARRANTIES, EXPRESS OR IMPLIED. ALL WARRANTIES OTHER THAN THE EXPRESS WARRANTY SET FORTH HEREIN ARE HEREBY EXPRESSLY DISCLAIMED TO THE EXTENT PERMITTED BY LAW.

We expressly disclaim all liability for special, consequential, or incidental damages, whether arising in tort or by contract from any breach of this warranty. Some states do not allow the exclusion or limitation of incidental or consequential damages, so the above limitation or exclusion may not apply to you. We further disclaim liability from personal injury relating to its products to the extent permitted by law. By acceptance of any of our products, the purchaser assumes all liability for the consequences arising from their use or misuse. No person, firm or corporation is authorized to bind us to any other obligation or liability in connection with the sale of our products. Furthermore, no person, firm or corporation is authorized to modify or waive the terms of this warranty unless done in writing and signed by a duly authorized agent of ours. In no case shall our liability for any claim relating to our products, your purchase or your use thereof, exceed the original purchase price paid for the product.

WARRANTY CLAIMS

To file a claim against this Limited Warranty, users must

1. Contact AcuRite Support at support@chaney-inst.com and provide opportunity for Customer Support to resolve any issue
2. In the event that an issue cannot be resolved over the phone, customer shall send the product(s) in for evaluation to AcuRite at the contact address (see below)
3. Chaney Instrument Service department will repair or replace product as necessary after evaluation

The terms of this Limited Warranty shall be governed in all respects by and construed in accordance with the laws of the State of Wisconsin, USA, without regard to its conflicts of law principles, and exclusive jurisdiction over any cause of action arising out of this Limited Warranty or your use of the product shall be in the state court located in Walworth County, Wisconsin. You agree to submit to the jurisdiction of such court.

Contact Information

If you have questions about this Limited Warranty, please contact us at:

AcuRite
Attn: Warranty Inquiry
965 Wells St, Lake Geneva, WI 53147
warranty@chaney-inst.com

©Chaney Instrument Co. All rights reserved. AcuRite is a registered trademark of the Chaney Instrument Co., Lake Geneva, WI 53147. All other trademarks and copyrights are the property of their respective owners. AcuRite uses patented technology. Visit www.AcuRite.com/patents for details.

Printed in China
06059 INST 091218